

LED Auxiliary Work Light - Model TS3001R

PRODUCT INFORMATION

Description	12-24V DOT LED Auxiliary Light with Driving Beam - 1 Light
Height	172.72 mm / 6.8 in
Width	152.40 mm / 6 in
Depth	104.14 mm / 4.1 in
Shape	Round
Outer Lens Material	Polycarbonate
Outer Lens Color	Clear
Housing Material	Xenoy
Housing Color	Black
Mounting Hardware Description	(x1) 3/8-16 x 1.5" Stainless Steel Screws
Mounting Type	Bracket
Connector or Wiring	Integral Deutsch DT04-2P
Mating Connector	DT06-2S
Product Weight	2.03 lbs / 0.92 kgs
Shipping Weight	2.03 lbs / 0.92 kgs



PRODUCT DIMENSIONS

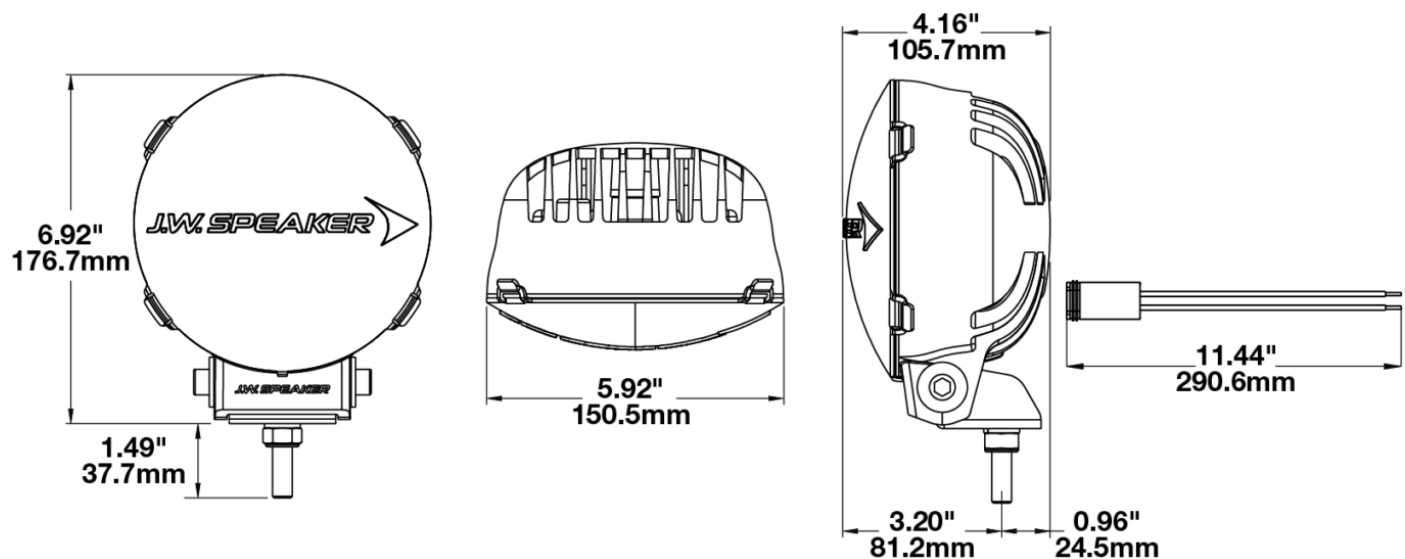

Print date: 2024-08-11

© 2024 J.W. Speaker Corporation • Germantown, WI U.S.A.
www.jwspeaker.com • speaker@jwspeaker.com • 262.251.6660

J.W. SPEAKER
 Engineered. Lighting. Solutions.

LED Auxiliary Work Light - Model TS3001R

ELECTRICAL SPECIFICATIONS

Input Voltage	12-24V DC
Operating Voltage	9-32V DC
Red Wire	Positive
Black Wire	Negative
Current Draw	1.15A @ 12V DC (Standard) 0.60A @ 24V DC (Standard) 2.15A @ 12V DC (Jeep) 1.00A @ 24V DC (Jeep)

REGULATORY STANDARDS COMPLIANCE

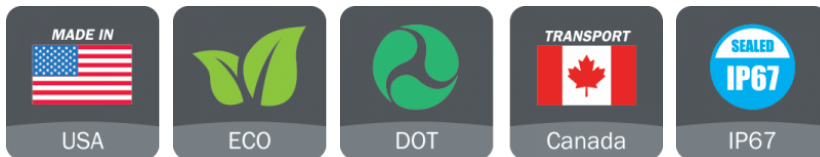

Buy America Standards Eco Friendly
FMVSS 108 s10.1 (Table XVIII) IEC IP67

PHOTOMETRIC SPECIFICATIONS

Raw Lumen Output	1,960
Effective Lumen Output	1,080
Candela Output	55,000
Beam Pattern(s)	Forward Lighting - Driving

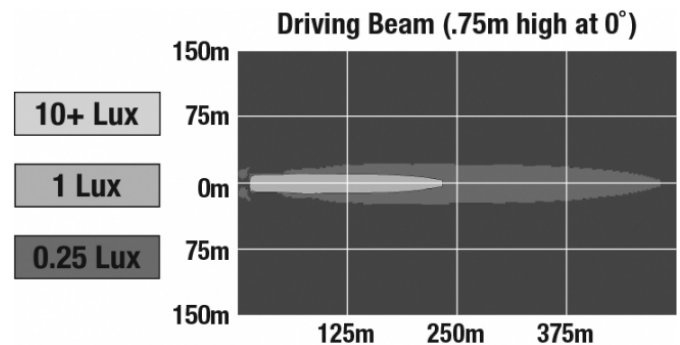

Print date: 2024-08-11

© 2024 J.W. Speaker Corporation • Germantown, WI U.S.A.
www.jwspeaker.com • speaker@jwspeaker.com • 262.251.6660

LED Auxiliary Work Light - Model TS3001R

APPLICATIONS

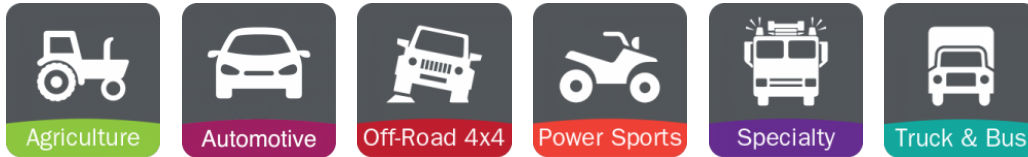

PRODUCT WARNINGS

For California residents:

⚠ **WARNING:** Cancer and reproductive harm - www.P65Warnings.ca.gov.

⚠ **AVERTISSEMENT:** Cancer et effet nocif sur la reproduction - www.P65Warnings.ca.gov.

ACCESSORIES



Part Number
5874271
Clear Replacement
Lens Cover for Model
TS3001R



Part Number
5874281
Amber Replacement
Lens Cover for Model
TS3001R



Part Number
5874291
Red Replacement Lens
Cover for Model
TS3001R



Part Number
5874301
Blue Replacement
Lens Cover for Model
TS3001R



Part Number
6149203
A-Pillar Mounting Kit
for Jeep JK



Part Number
6149233
A-Pillar Mounting Kit
for Jeep TJ

Print date: 2024-08-11

© 2024 J.W. Speaker Corporation • Germantown, WI U.S.A.
www.jwspeaker.com • speaker@jwspeaker.com • 262.251.6660

LED Auxiliary Work Light - Model TS3001R

RELATED PRODUCTS



Part Number
0550443
12-24V DOT LED
Auxiliary Light with
Driving Beam - 2 Light
Kit



Part Number
0550461
12-24V ECE LED
Auxiliary Light with
Driving Beam - 1 Light



Part Number
0550463
12-24V ECE LED
Auxiliary Light with
Driving Beam - 2 Light
Kit



Part Number
0550481
12-24V LED Auxiliary
Light with Pencil Beam
- 1 Light



Part Number
0550483
12-24V LED Auxiliary
Light with Pencil Beam
- 2 Light Kit